

ULTRAMIX® TX95

High productivity thermostatic mixing valve

Technical data sheet



Description

Thermostatic mixing valves with a double regulation functioning according to a principle of servo-motor. Water mixing is obtained by two independent valves, (one for hot water, one for cold water), which operate like two hydraulic relays. These two valves are controlled by a bimetallic strip that records output water temperature and can be adjustable also with the calibrated control knob.

- Continuous PROTECTION AGAINST LEGIONELLA provided the loop return temperature in 55°C.
- SCALD PROTECTION: the hot water shuts off automatically if there is not enough cold water. (provided that the Delta between hot and mixing water is higher than 10°C).
- MAXIMUM TEMPERATURE LIMITATION adjustable and lockable.
- LIMITED MAINTENANCE: no friction from moving metal parts which reduces the risk of scaling and thus increases longevity.
- BIMETALLIC STRIP TECHNOLOGY: exceptional qualities of regulation and resistance to the scale (crucial factor for safety).
- SIMPLE AND EASY MAINTENANCE: removal cartridge without dismantling the thermostatic mixing valve, strainers and integrated check valves accessible directly on the cartridge.
- PRECISION OD ADJUSTMENT to +/-2°C and temperature stability at both low and high flow rates ensure maximum COMFORT of use
- GUARANTEE: thermostatic mixing valve and cartridge guaranteed 5 years.



ULTRAMIX® TX95

Thermostatic mixing valve, with built-in blocking control knob. Cover in front (grey PVC or chrome plated).

Calculation software access:
[Click here](#)

Connect.	Flow (l/min)	Setting range	Finish	Points of use*	Part number	Weight (kg)
M 1"1/2	Min. 8 – Max. 260	10/50°C	Grey epoxy	1 to 32	22TX95E	7,8
M 1"1/2	Min. 8 – Max. 260	10/50°C	Chrome plated	1 to 32	22TX95C	7,8
M 1"1/2	Min. 8 – Max. 260	30/70°C**	Grey epoxy	1 to 32	22TX95E37	7,8
M 1"1/2	Min. 8 – Max. 260	30/70°C**	Chrome plated	1 to 32	22TX95C37	7,8

Standard gradations: 10/50°C or 30/70°C, on request and without extra charge: 5/40°C.

* For information - please take into account the number of taps connected to the same network and used simultaneously.

** Anti-legionella prevention, provided the blocking return is 55°C

Technical features

Technical features	
Maximum pressure	10 bar
Maximum dynamic pressure	6 bar
Recommended operating pressure	2 - 4 bar
Minimum operating pressure	1 bar
Maxi. hot temperature supply	85°C
Flow mini.	8 l/min
Max. dynamic flow at 3 bar	260 l/min
Minimum temperature variation between inlets	10°C
Maximum pressure variation	1 bar

* differential minimum hot/mix temperature must be > 10°C.

For optimum flow, the Delta between hot and mixing water must be higher than 20°C

Nomenclature and materials

N°	Designation	Materials
1	Body	Brass
2	Cartridge TX5 (10/50°C) Cartridge TX537 (30/70°C)	Brass + stainless steel + EPDM + covered steel
3	Cover M2	Plastic
4	Knob	Plastic
5	Screw	Stainless steel

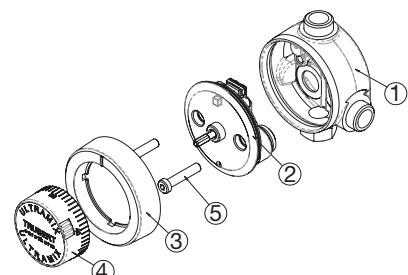

Approvals



Application

The ULTRAMIX® TX95 thermostatic mixing valve is specially designed for collective installations from 1 to 32 points of use (refer to the software access) with a hot water inlet on the left and a cold water inlet on the right. Reverse inlets are possible on request and without extra charge.



Installation

The hot water has to be connected on the left side and the cold water on the right side and connect the mixed water outlet. Provide an accessible shut-off valve on each pipe. Rinse pipes with the supplied kit and turn on the thermostatic mixing valve (do not throw away the rinse kit : keep it next to the mixing valve for maintenance operations). Adjust the temperature. You can install the Ultramix mixing valve on the left or the right (see diagrams opposite). However, a downward mixing water outlet is not recommended. Please, refer to the complete instructions supplied with the thermostatic mixing valve or on wattswater.eu.

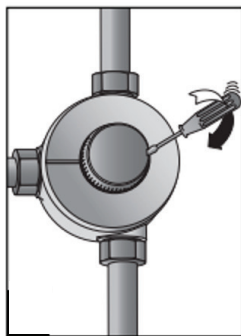

Mixed water inlet on the left

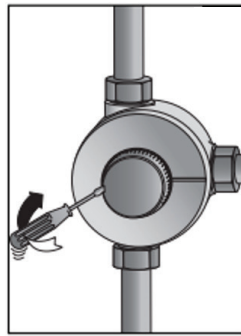

Mixed water inlet on the right

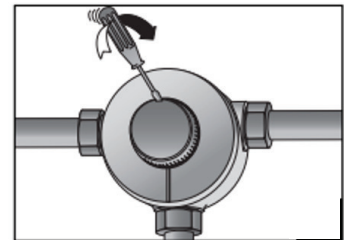

Mixed water outlet downwards
It is not recommended to position the mixed water inlet downwards (symptom: variation in mixed water temperature that does not remain stable)

Setting

Mixed water temperature adjustment: this adjustment is done autonomously without the loop circulation pump.

1. Stop the loop circulation pump.
2. Close the pump isolation valves.
3. Open sufficient points of use on the mixed water circuit to obtain the minimum flow of the thermostatic mixing valve.
4. Turn the thermostatic mixing valve axis control shaft to reduce or increase the mixed water temperature.
5. Once the required temperature is obtained, replace the control knob.

Against legionella answer

Thanks to the ULTRAMIX® TX95 (with setting range 30/70°C) there are 2 solutions against legionella:

- You can with the thermostatic mixing valve such as it is (with 30/70°C cartridge): proceed to a thermal "shock", simply by freeing the control knob and position it a 70°C (without dismantling the thermostatic mixing valve, cartridge or control knob).
- You also can by putting the cartridge in position "rinsing" i.e. turned over cartridge, fixed at back, (see simple procedure and the rinsing kit delivered with the thermostatic mixing valve (for mixing valves with 10/50°C setting): proceed to a thermal "shock" with more 70°C, without risk to damage the thermostatic mechanism prematurely, because is not any more in contact with water.
- You can also carry out a chemical disinfection (to do this, put the cartridge in RINSE mode (kit supplied with the mixing valve) at a maximum temperature of 30°C). Once finished, rinse the entire system. High-temperature disinfection will damage all the elastomers in the mixing valve, as well as the system in general

Replacement cartridges ULTRAMIX®

The thermostatic mechanisms are independent from the other parts of the thermostatic mixing valves.

This modular system, facilitates the first start-up and the maintenance (possibility of cartridge exchange).

Any installation defect is immediately detected and allows a quick compliance.

All Eurotherm "cartridges" of ULTRAMIX®, high productivity thermostatic mixing valve, have stainless steel filters and check valves NF approved.



For mixing valve type	Flow (l/min)	Setting range	Part number
TX95E, TX95C	Min. 8 – Max. 260	10/50°C	22TX5*
TX95E37, TX95C37	Min. 8 – Max. 260	30/70°C	22TX537*

* For reversed cartridges add "IN" to the article code.

Maintenance

WATTS INDUSTRIES recommends to minima, the installation of a thermometer of control of the temperature on the mixed water piping and one on the return of loop, and that this temperature is checked at least once a month under the normal conditions of operation. This thermometer must be installed at a distance from at least 1 meter of the thermostatic mixing valve.

The rinsing kit is delivered with the thermostatic mixing valve and allows to facilitate the intervention in case of preventive or curative treatment.

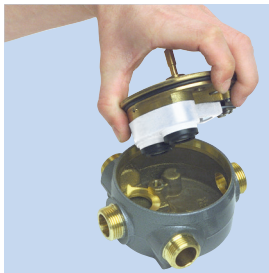

Take off the knob, cover, and stainless steel screw (keep the stainless steel screws in a safe place so that you can refit the cartridge using the stainless steel screws ; do not use the screws from the rinse kit). Remove the cover/cartridge from its casing.



Place the flat washer (included in package) on the device's neck.



Place the cover/cartridge unit upside down on the device and flat washers.



Tighten the temporary screws (included in the rinse kit package). The valves act now as a "by-pass".

The principle of compact mechanism in the form of interchangeable cartridge allows a handing-over under operation of the thermostatic mixing valves in record time. This great simplicity of maintenance makes it possible to utilize a person without particular qualification and not to immobilize an installation more few minutes, so much the exchange of the mechanism is fast. Moreover, the body of the thermostatic mixing valve is never dismantled of the installation.

Maintenance kit for ULTRAMIX® cartridge

This kit includes all the usual wearing parts:

the cover-cartridge gasket ❶, 2 filter-support (elastomer) ❷, gaskets for cover screws ❸, 2 stainless steel strainers ❹, the check valve units and assembled check valve carriers ❺ and the cover screws ❻.

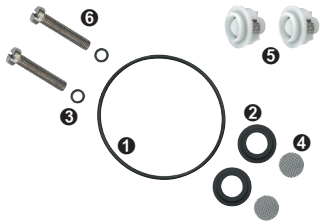

For cartridge type	Part number complete kit	Part number simplified kit
TX5, TX537	22TB120005	22TB120025 (without cover screws)

Sizing (mm)

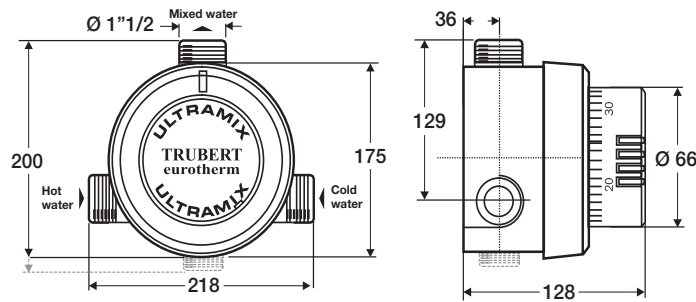

Operating (flow curve)

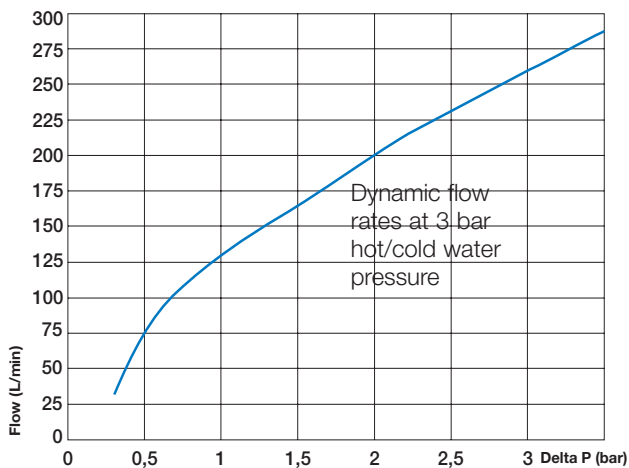

The descriptions and photographs contained in this product specification sheet are supplied by way of information only and are not binding.

Watts reserves the right to carry out any technical and design improvements to its products without prior notice. Warranty : All sales and contracts for sale are expressly conditioned on the buyer's assent to Watts terms and conditions found on its website at www.watts.com. Watts hereby objects to any term, different from or additional to Watts terms, contained in any buyer communication in any form, unless agreed to in a writing signed by an officer of Watts.



Follow us   
Watts Water Technologies

WATTS INDUSTRIES France

1590 avenue d'Orange • CS 10101 Sorgues 84275 VEDENE CEDEX • FRANCE

Tél. +33 (0)4 90 33 28 28 • Fax +33 (0)4 90 33 28 29/39

contact@wattswater.com • www.watts.eu